

V2



Installation manual



BMW E46 7inch Android

Are you ready to install our unit?

Let's go >>>

5 steps to install

STEP 01 Double check if has any missing before installation.

STEP 02 Check
1) Do the screen is broken ?
2) Do the accessories have missing ?

STEP 03 Test your unit before installing into your car
(Connect the power cable to your car)

STEP 04 Do the full installation.

STEP 05 Test the head unit functions.

STEP 01 Double check if has any missing before installation.

In this case, the installation can't be plug & play if your car dash radio plug is same as shown on the right picture.

You need to separately purchase an extension harness for connecting the head unit and the BM54/24 amp in the trunk area.

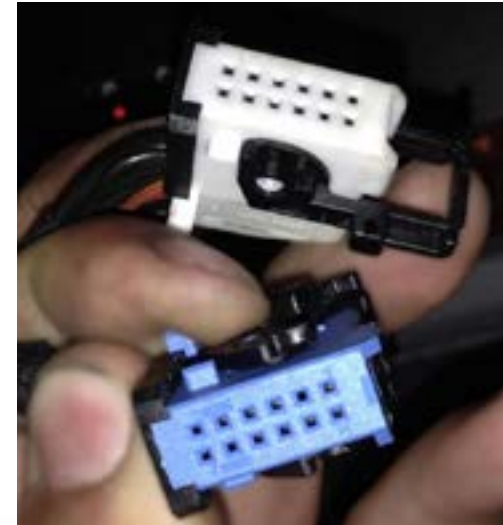

5m extended harness

Please find the ASIN in the listing.

Installation guide

If you are in above three situations, your car should be built-in an amplifier - **BM54/24 tuner** in the trunk area. You need to use the extended harness to connect both of them.



The references of BM54 tuner location



Installation steps

1. Connect the power plug to the new head unit.
2. pull the extension harness to the trunk area as shown.



4

3. Connect the female radio plug of your car with the male plug of extended harness.

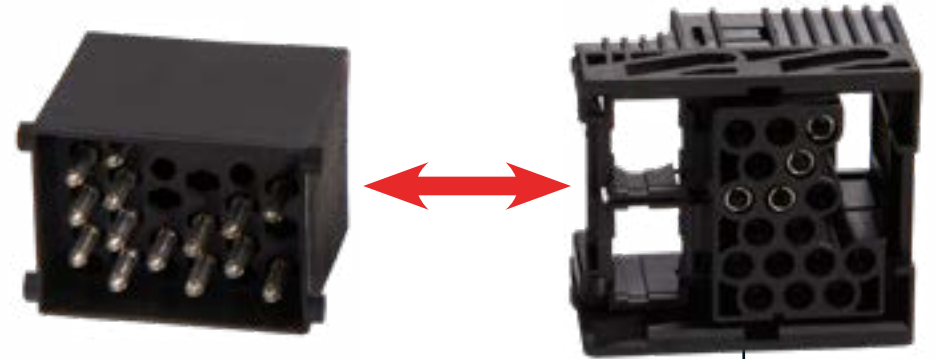

From extended harness

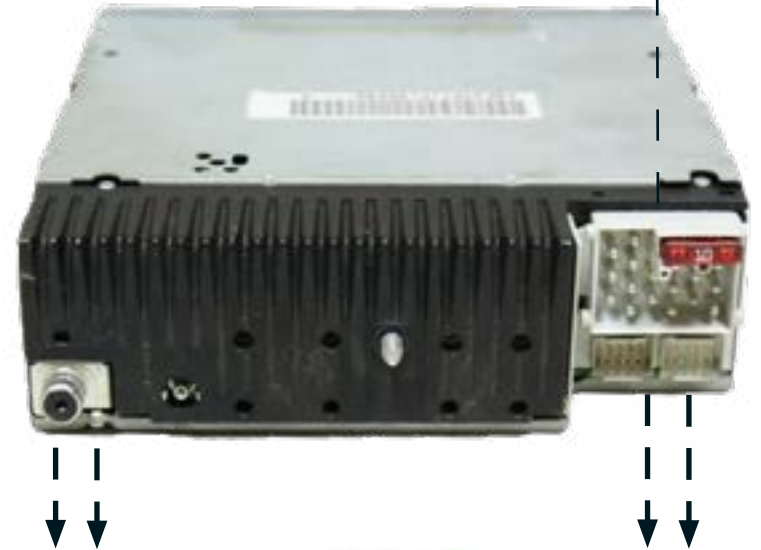

5

4. Connect the female plug of extension harness with the amplifier - BM54/24 tuner.



From extended harness



If the factory plug like below(only 17pin and lack of 4pin). It's not compatible with our Amaseaudio head unit.

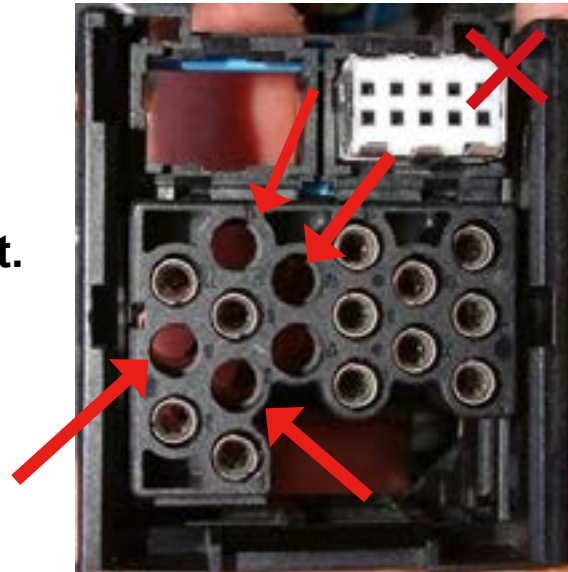

Accessories



- | | |
|---------------------------|-------------------------------|
| 1. Power cable *1 | 9. Radio antenna connector *1 |
| 2. GPS antenna *1 | 10. Disassembly tool *1 |
| 3. USB adapter cable *1 | 11. 3M adhesive *1 |
| 4. Wi-Fi antenna *1 | 12. 15A fuse *1 |
| 5. External microphone *1 | 13. Radio antenna adapter *1 |
| 6. Canbus *1 | 14. Long screw *2 |
| 7. USB adapter cable *1 | 15. A&V output harness *1 |
| 8. USB adapter cable *1 | 16. Disassembly key *2 |
| | 17. Warranty card *2 |

STEP 03 Test your unit before installing into your car (Connect the power cable to your car)

1. Double check the size and shape of the center console panel.



2. Pry the decoration strip from edge with the plastic tool



3. Take out the decoration strip



4. Remove the 2 fixed screws on the factory CD player with a Philips screwdriver.



5. Take out the factory CD player, the AC controller and the storage box.



Now you can take out the power cable to connect the head unit and then try to turn it on. If this part is no problem, you can do the remain steps.

STEP 04 Do the full installation.

6. Replace the AC controller to the place of storage box.



7. Remove the 4 fixed screws of the factory mounting bracket with a Philips screwdriver and take out the bracket



8. Connect those wires provided in the package like (1) Power cable with canbus, (2) USB cable, (3) Radio antenna adapter cable, (4) GPS antenna, (5) Wi-fi antenna and (6) External microphone as shown.

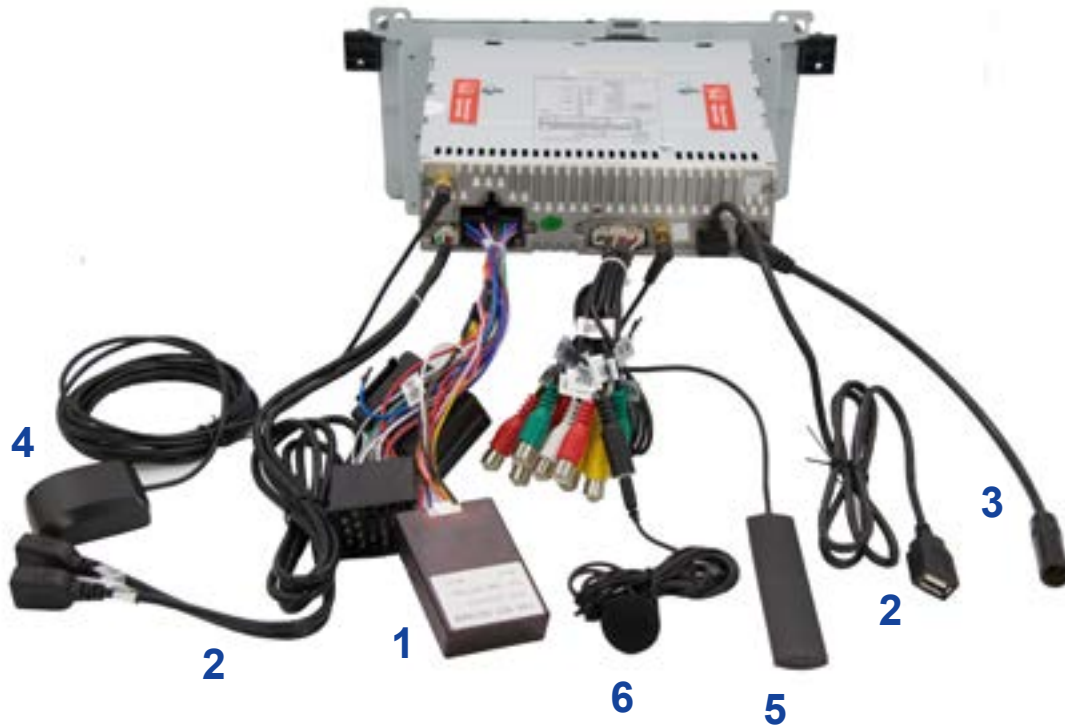

Wiring diagram

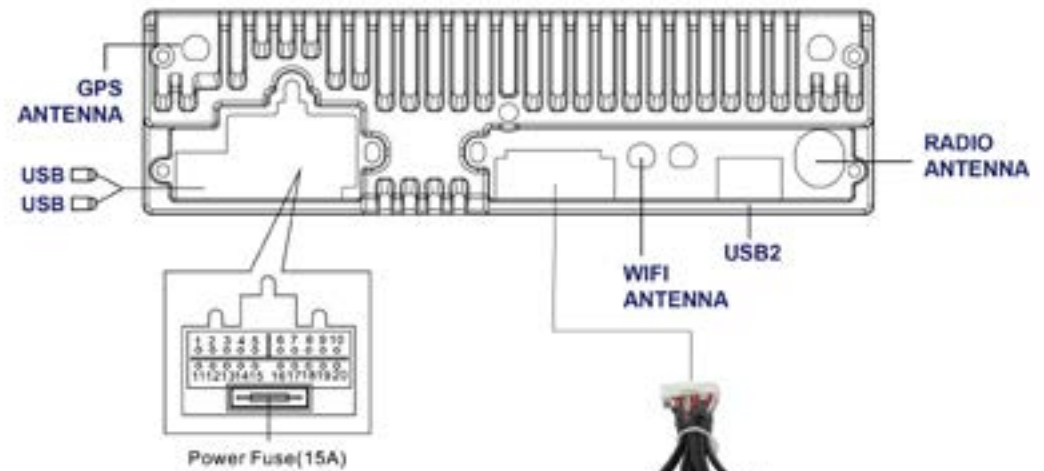

1. Power amplifier control
2. Steering wheel control 2
3. Steering wheel control 1
4. Brake wire
5. Auto antenna power
6. Rearview control wire
7. Rear left speaker-
8. Rear left speaker+
9. Rear right speaker-
10. Rear right speaker+
11. CANBUS TX (IR)
12. CANBUS RX (GND)
13. ILLUMI
14. Accessory
15. Ground
16. Power+12V
17. Front left speaker-
18. Front left speaker+
19. Front right speaker-
20. Front right speaker+



9. Plug the head unit into the center console, then place the GPS antenna and microphone as shown. The wires are hidden in the side of pillar trim and led to the head unit.

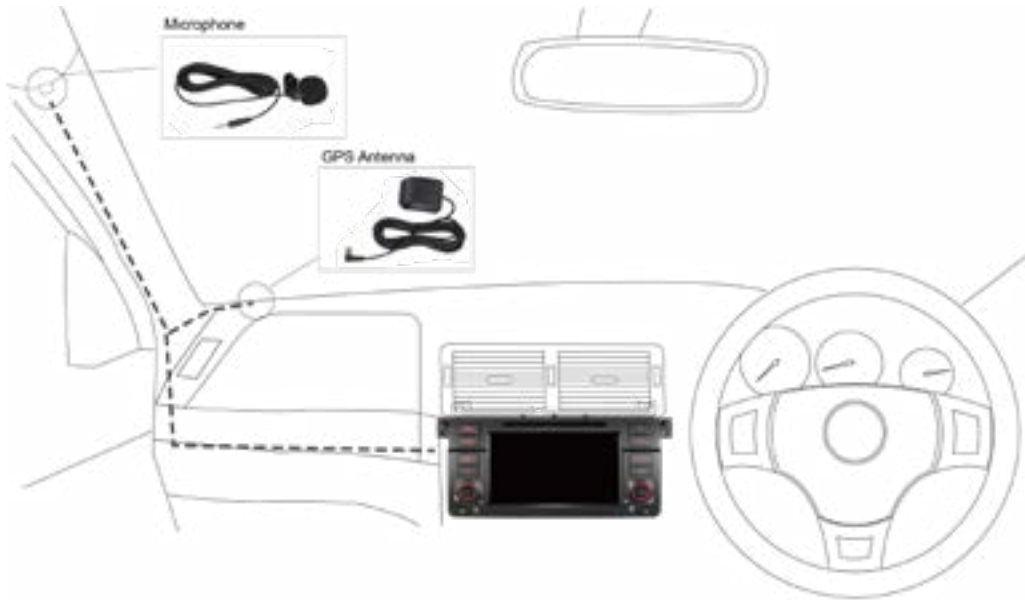

STEP 05 Test the head unit functions.

(FM, SD, USB, Bluetooth, reversing, handbrake, headlight, steering wheel control and etc)



Wire connection for the amplifier, the subwoofer and the headset monitors

Case 1: Subwoofer connects to the head unit



Case 2: The external amp and the speakers are connected to the head unit.

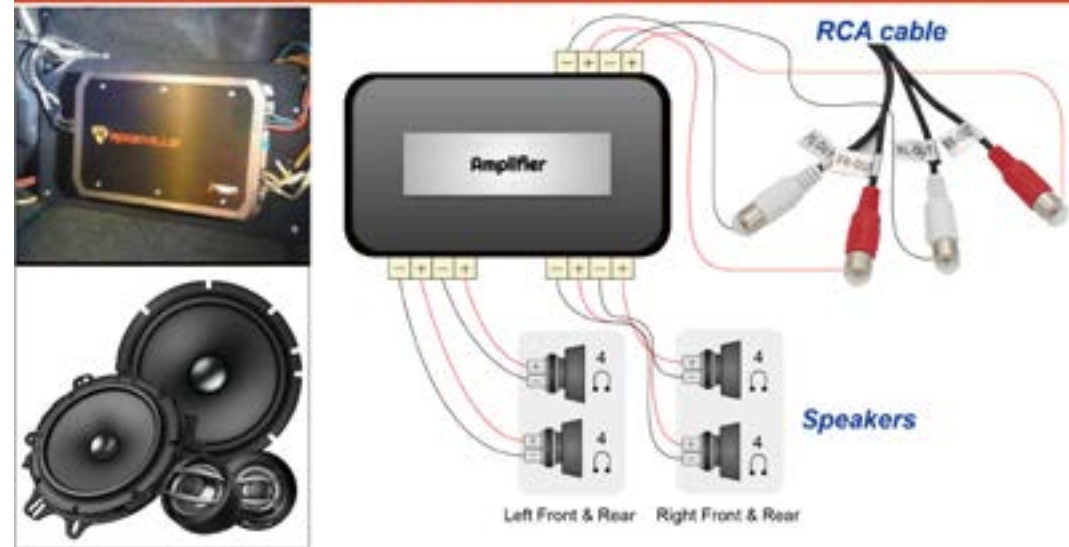

Case 3: The external amp + the speakers and the subwoofer both with independent amp are separately connected to the head unit.

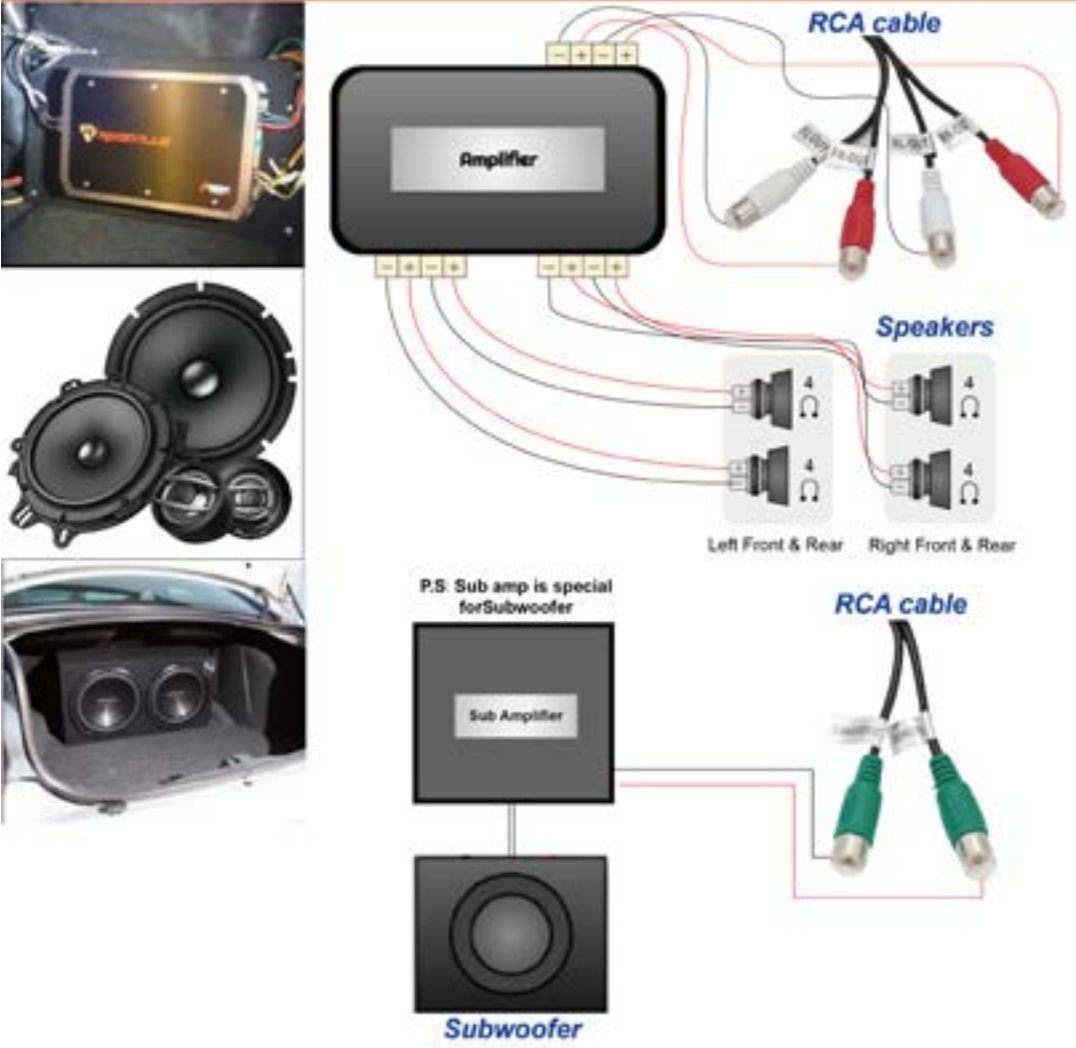

Optional : Install a rear camera

Our main unit only syncs the rear camera but not the front camera.



Cable connection



System Initial setup

1 Set radio location

The default radio country in the unit is Europe, if you are from other country, you need to access the "factory mode (PW: 126) > Radio" to adjust the country.

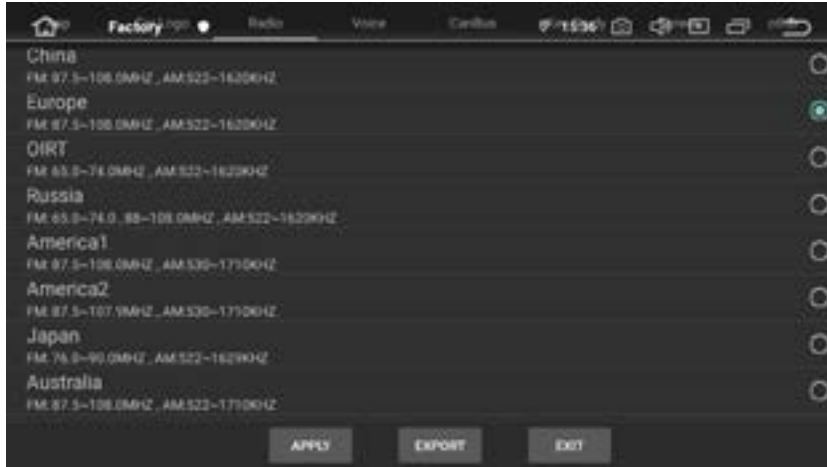

2 Set RDS

The Radio has RDS function but this function is only for Europe, if the clients from other countries use it, it will affect the radio reception, so please close it.



3 Set the unit language

Please go to setting > Languages & input, then you can add the desirable language you need.

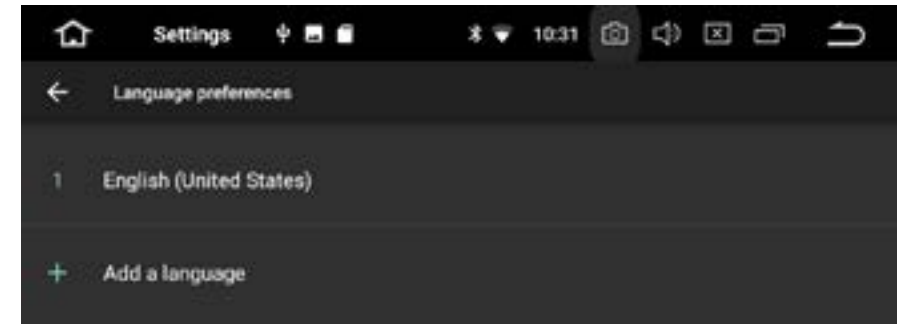

About after sales service

Q: Do my head unit has one year maintenance?

A: Definitely yes, you will have our commitment after you purchase.

(The maintenance period will base on the date you make the order)